

Rain sensor WLA 331

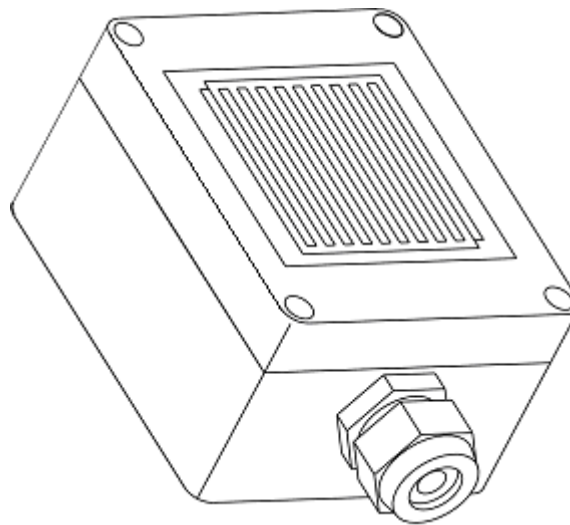

Table of contents:

- Technical function description
- Operating/control and display elements
- Connection to control units
- Settings
- Technical data

DK	+45 4567 0300	info.dk@windowmaster.com
DE	+49 (0) 5221 6940 – 500 Vertrieb / - 650 Technik	info@windowmaster.de
UK	+44 (0) 1536 510990	info@windowmaster.co.uk
CH	+41 (0) 62 289 22 22	info@windowmaster.ch
Other markets	+45 4567 0300	info@windowmaster.com



Technical function description – rain sensor WLA 331

Description:

The rain sensor comprises a rain sensor surface.

This sensor is used for the automatic control of smoke ventilation and comfort ventilation units.

The rain sensor is equipped with a potential free change-over contact having a contact rating of 60V/2A.

In the event of rain, the change-over contact switches over from the N/C contact to the N/O contact.

The settings for the wind trigger threshold, the actuation delay, the drop out delay and the trip in the event of a mains failure are made by a 6 pole DIP switch in the sensor.

Operation / Function:

Triggering by rain:

The potential free contact switches when the rain sensor trips.

The red LED in the sensor is lit.

Remark:

The trip is reset 10 or 20 min. (settable) after the last sensor actuation.

Operation/control and display elements – rain sensor WLA 331

For assembly, remove plug connection from the cover.
Do not mismatch during assembly.

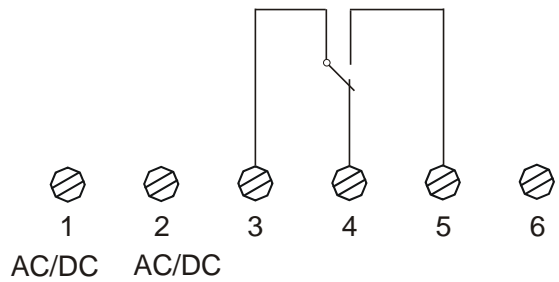
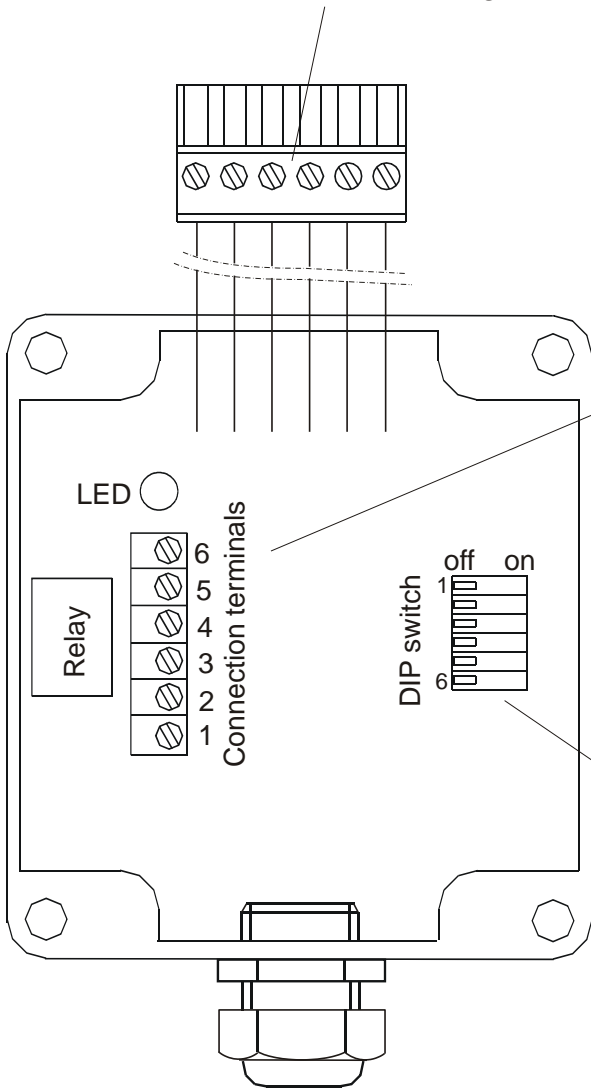

Terminal 1 = Supply voltage AC/DC
Terminal 2 = Supply voltage AC/DC
Terminal 3 = Relay (arm)
Terminal 4 = Relay (N/C contact)
Terminal 5 = Relay (N/O contact)

Terminal 6 is internally connected to terminal 2.

Connection (DIP switch 6 = off)

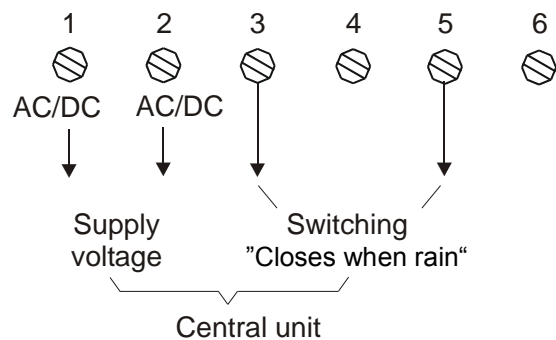

Connection (DIP switch 6 = on)
automatic trip in the event of a supply voltage failure

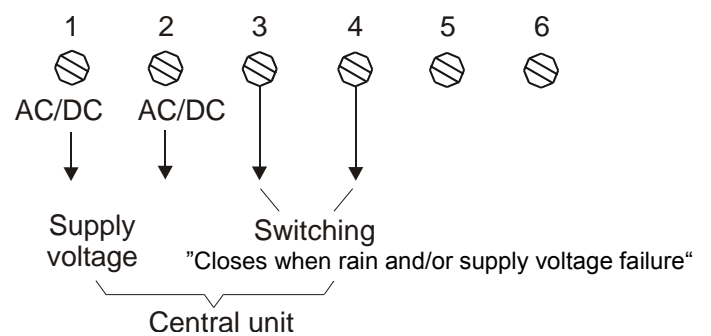

Connection to control units – rain sensor WLA 331

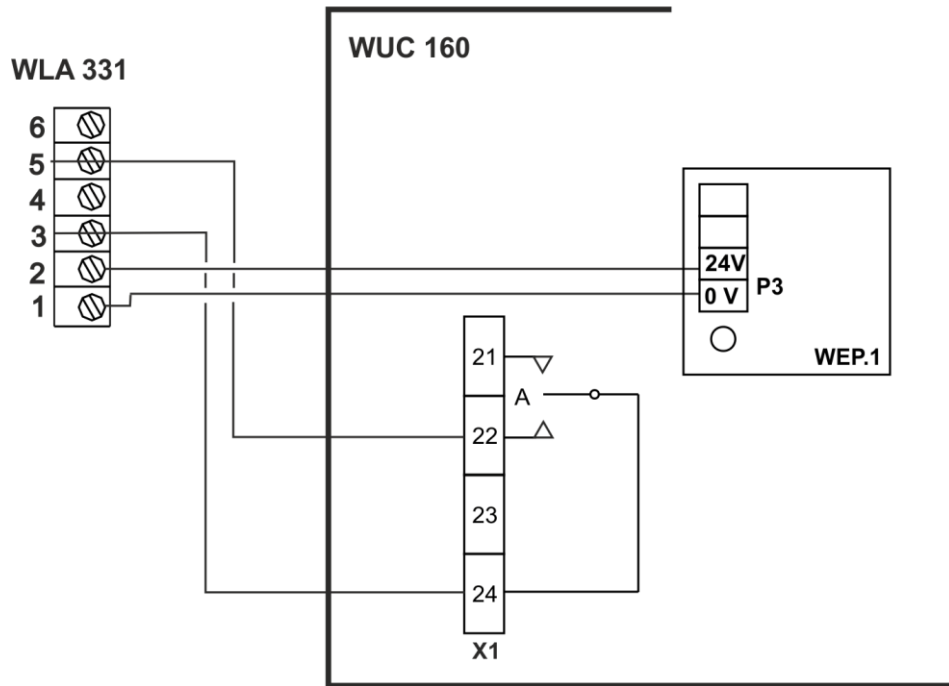
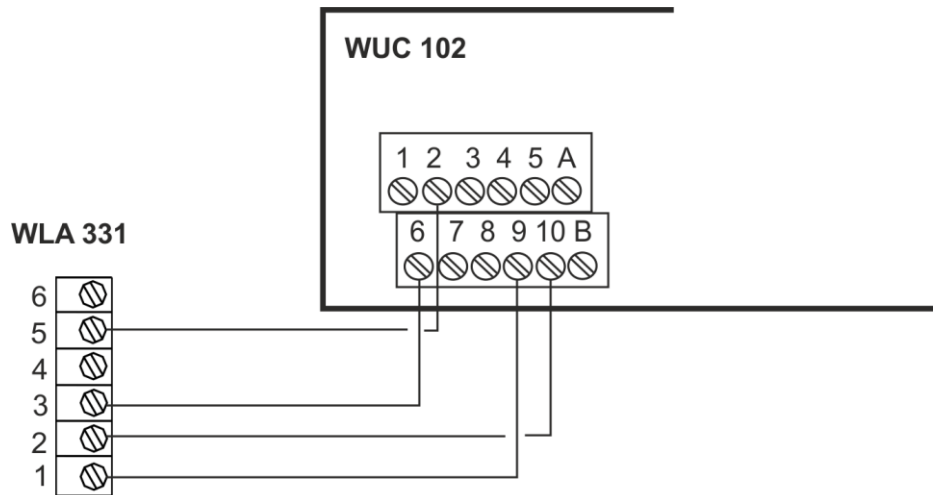

Settings – rain sensor WLA 331

Various rain parameters and operating modes can be set by means of the installed DIP switches.

DIP switch settings

	Test	Operation
Switch 1	off	on
Switch 2	off	on
Switch 3	off	on

Note:

Factory setting = operation, meaning switch 1+2+3 = on and all other switches = off.

Should there during installation be the need to disconnect the rain drop out delay, set switch 1+2+3 = off (= Test).

Important! Once installation and star-up are completed, the switches 1+2+3 MUST be on!

Remark: In the test setting, the activation and drop out delay is deactivated!

DIP switch settings

	Switch setting OFF	Switch setting ON
Switch 4 = deactivated		
Switch 5 = Rain drop out delay	10 minutes	20 minutes
Switch 6 = Monitoring	Off	on

Information regarding switch 6:

Only the supply voltage (terminals 1+2) for the sensor is monitored.

The system will trip automatically in the event of a supply voltage failure.

Technical data – rain sensor WLA 331

Display:

Red steady light in the sensor LED = Sensor tripped by rain.

Technical data

Supply voltage:	18V to 26V AC or 20V to 32V DC
Circuit output:	1 x potential free change-over contact
Switching capacity:	60V / 2A
Sensor dimensions:	80 x 80 x 55mm (WxHxD)
Sensor weight:	approx. 0.3kg
Sensor protection type:	IP65
Setting of the rain drop out delay:	10 min. / 20 min.
Setting of the monitoring:	Off / On
CE sign:	in accordance with the EMC directive and the low voltage directive

Connection:

Terminal 1 = Operating voltage AC/DC

Terminal 2 = Operating voltage AC/DC

Terminal 3 = Relay (arm)

Terminal 4 = Relay (N/C contact)

Terminal 5 = Relay (N/O contact)

Miscellaneous:

Only allow qualified personnel to connect the control system.

Note the VDE 0100 for 230 Volt main connection.

Note VDE 0855 as for aerial systems with regard to the mechanical stability, electrical safety and lightning protection.

Clean the sensor regularly depending on the degree of soiling.